

Graveyard Recording Code Sheets

Denomination

- 10 Christian (denomination not known)
- 11 Anglican/Episcopalian
- 12 Roman Catholic
- 13 Baptist
- 14 Presbyterian
- 15 Methodist
- 20 Orthodox (denomination not known)
- 21 Greek Orthodox
- 22 Russian Orthodox
- 50 Jewish (denomination not known)
- 51 Jewish (Ashkenazi)
- 52 Jewish (Sephardic)
- 60 Islamic
- 90 Pet cemetery

Condition of monument

- 1 Sound and in situ (even if leaning)
- 2 Sound, but displaced
- 3 Falling apart, incomplete but recognisable
- 4 Collapsed and form unknown
- 5 Overgrown

Condition of inscription

- 1 Mint
- 2 All legible
- 3 Mainly legible
- 4 Traces
- 5 Illegible/destroyed/face down
- 9 Never inscribed

Orientation

The orientation of a stone indicates which way it *faces*. Most headstones are at the head of the grave and *face* towards the east. The orientation is measured in degrees

Where to take measurements for monuments **without** a base.

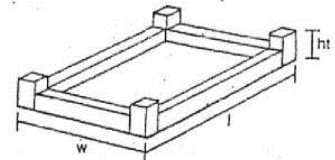
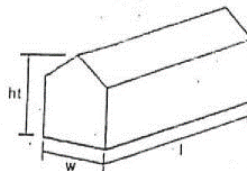
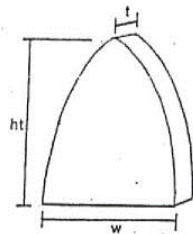

Monument dimensions

The **main** measurements for a monument with a base

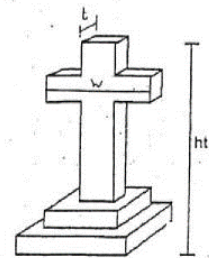
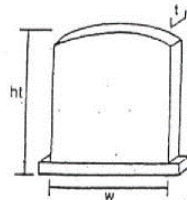
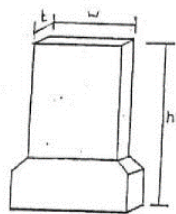

The **base** measurements

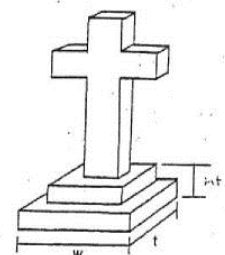
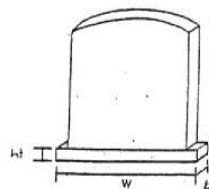
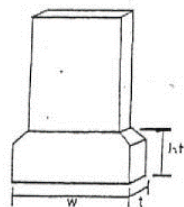

Materials

10	Slate	54	Black-glazed ceramic
13	Purple slate	55	Brown-glazed ceramic
20	Marble (usually white but often discoloured)	56	Cream-glazed ceramic
30	Granite	60	Iron
31	Pink granite	65	Brass
32	Grey granite	70	Conglomerate
33	Black granite	75	Concrete
40	Sandstone	78	Mosaic (any materials)
41	Yellow sandstone	79	Glass
42	Red sandstone	80	Limestone
50	Ceramic	81	White limestone
51	Brick	82	Grey limestone
52	Tile	90	Other
53	Terracotta	95	Wood

Memorial Type

There is a four-digit numbering system which allows for recording and analysis at different levels of detail, and so is very flexible. The first digit indicates the type of monument (e.g. headstone, cross), the second a subset of this (e.g. round-topped, ringed), and the third can be used for further subdivision (e.g. indented sides, with stepped base) as can the fourth (e.g. with square shoulders, one step diamond shaped).

The monuments have been broken down into the following broad categories:

Kerb	0900
Chest and table tombs	1000
Crosses	2000
Sculpture	3000
Headstones	4000,5000, 6000, 7000, 8000
Pedestal tombs, mausolea	9000

Kerbs

When kerbs are not additional to any monument, but they form the monument themselves. 09 indicates kerbs; the third digit if there are stone posts, the fourth if the interior faced of the kerbs are bevelled (these often were used for text).

0900 Kerbs

0920 Plain kerbs

0940 Kerbs with posts at the corners

0960 Kerbs with 3 posts on each side

0970 Kerbs with high railings

0978 Railings only (no kerbs visible)

0980 Kerbs with chains

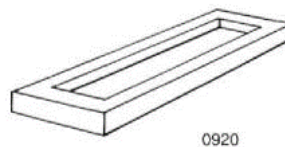

0920

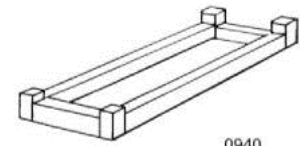

0940

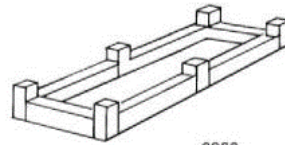

0960

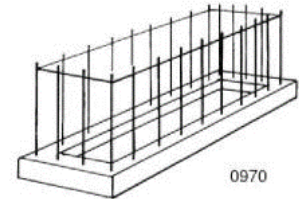

0970

Kerbs with bevelled/moulded internal faces:

0921 Plain kerbs

0941 Kerbs with posts at the corners

0961 Kerbs with 3 posts on each side

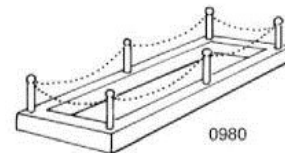

0980

Low monuments

0100 Ledger

0105 Ledger on a base or step

0200 Coffin shaped ledger

0310 Grave-rail

0330 Grave-board

0500 Low monument

0510 Low monument with flat top

0520 Low monument with convex top

0530 Low monument with gable top

0540 Low monument with hipped top

0550 Low monument with gabled cross

* * * 5 Low monument on a base or low step

0600 Cremation plaque set flush or
almost so with ground

0700 Rectangular plaque set flush with ground
(lawn cemetery style)

0705 Rectangular plaque set on low base
almost flush with ground (lawn cemetery style)

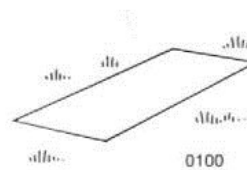

0100

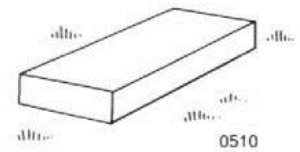

0510

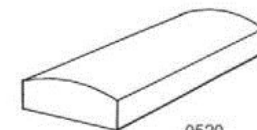

0520

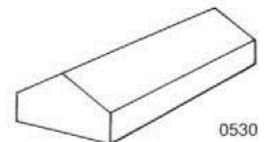

0530

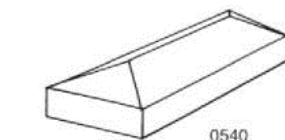

0540

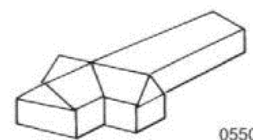

0550

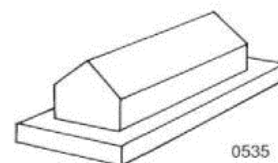

0535

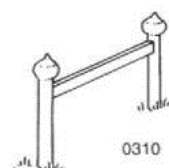

0310

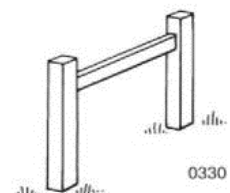

0330

Table and Chest tombs

- 1000 Tomb
- 1100 Chest tomb
- 1110 Chest tomb with plain sides
- 1120 Chest tomb with rectangular panelled sides
- 1130 Chest tomb with console ends
- 1300 Table tomb
- 1410 Table tomb, 4 straight square legs
- 1420 Table tomb, 4 baluster legs
- 1430 Table tomb, 4 animal legs
- 1440 Table tomb, 4 expanded legs
- 1610 Table tomb, 6 straight legs
- 1620 Table tomb, 6 baluster legs
- 1630 Table tomb, 6 animal legs
- 1640 Table tomb, 6 expanded legs
- 1700 Tomb with single central panel between end panels
- ***1 Square cut top
- ***2 Bevelled top
- ***3 Coped top
- ***4 Moulded top
- ***5 Single bale on top
- ***6 Double bale on top
- ***7 Low monument on top

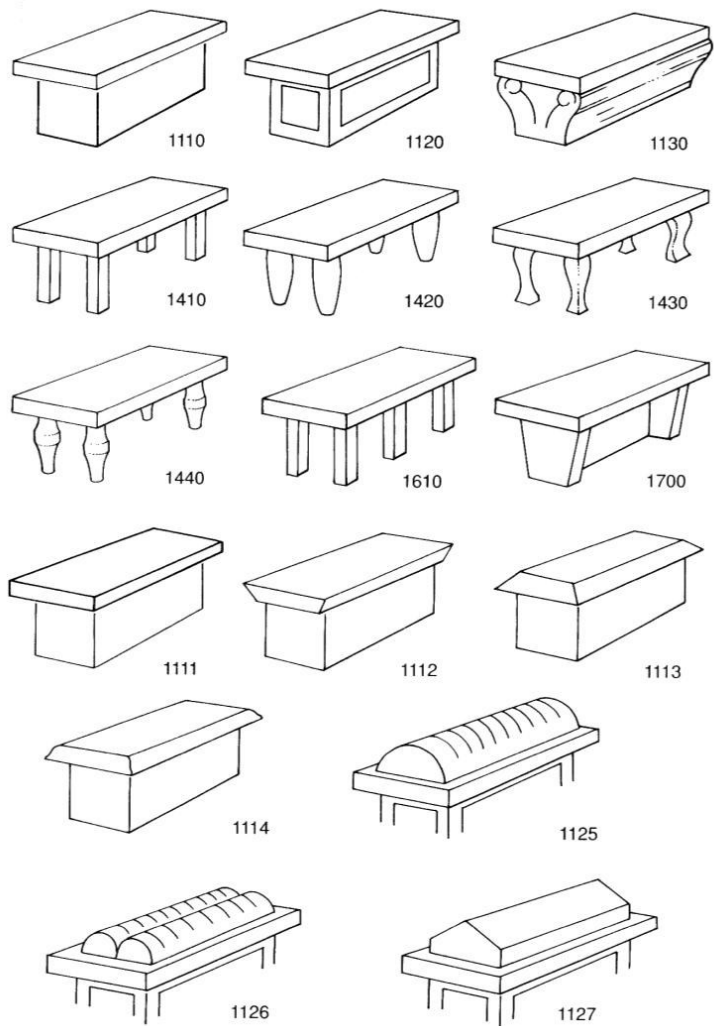

Crosses

- 2000 Cross
- 2100 Simple Latin cross
- 2200 Ringed cross
- 2300 Cross with expanded terminals
- 2400 Gothic cross
- 2500 Cross of Lorraine (with second arm at an angle)
- 2600 Cross with third arm
- 2700 Cross with gable
- **10 with 1 stepped base
- **20 with 2 stepped base
- **30 with 3 stepped base
- **40 with 4 stepped base
- **50 with rocky base
- **60 with roughly square base
- ***5 with one step diamond shaped

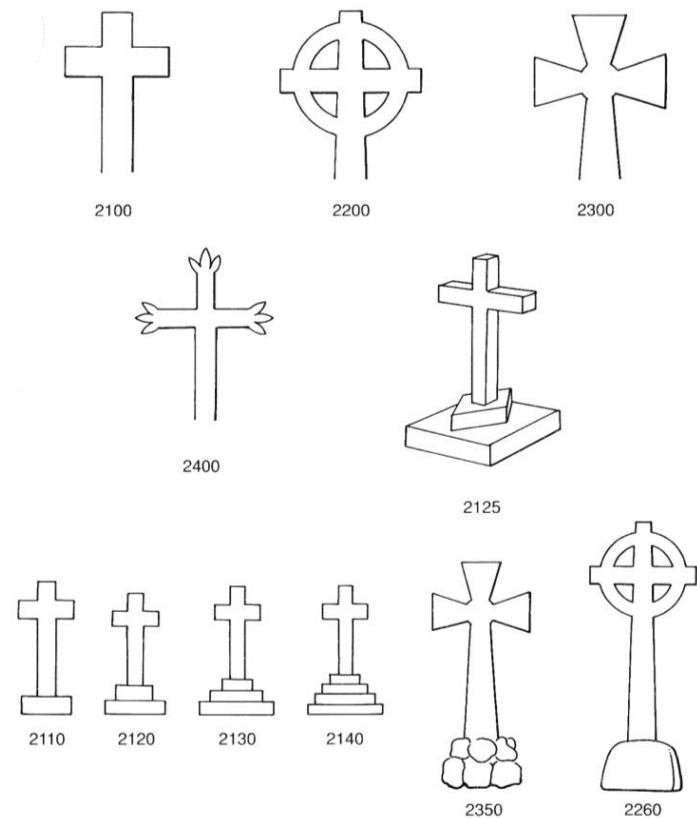

Headstones

- 4000 Headstone / Boulder / Rock grave marker
- 4100 Round top
- 4200 Gothic pointed top
- 4300 Triangular top
- 4400 Pedimented top
- 4500 Slightly curved top
- 4600 Sinuous top
- 4650 Topped with a cross
- 4660 Topped with a ringed cross
- 4700 Flat top
- 4770 With a cross on the side
- 4800 Concave pointed top
- 4900 Discoid (circular on shaft)
- 5100 Flat top with semicircular central feature
- 5200 Flat top with triangular central feature
- 5300 Flat top with slightly curved central feature
- 5400 Flat top with pointed oval central feature
- 5800 Asymmetrical top
- **50 Topped with a small cross (often a separate piece)
- **60 Topped with a small ringed cross

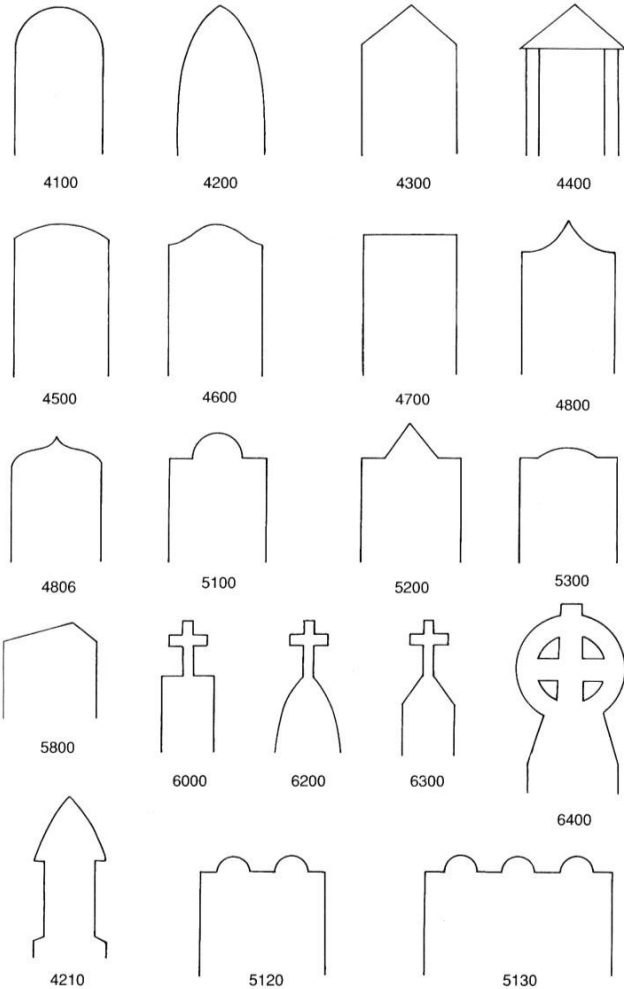

- Headstones with substantial integral cross on top (see **50, **60 for small crosses on top)
- 6000 With cross on top
 - 6100 With ringed cross on top
 - 6200 Gothic pointed headstone & cross on top
 - 6300 Gothic pointed with ringed cross
 - 6400 Triangular with cross
 - 6500 Triangular with ringed cross
 - 6600 Rounded top with cross
 - 6700 Rounded top with ringed cross

Features on shoulders of headstones

- ***1 Semicircular
- ***2 Quarter-circular
- ***3 Square
- ***4 Triangular
- ***5 Pointed
- ***6 Convex shoulders
- ***7 Concave shoulders
- ***8 Angled shoulders
- ***9 Stepped shoulders

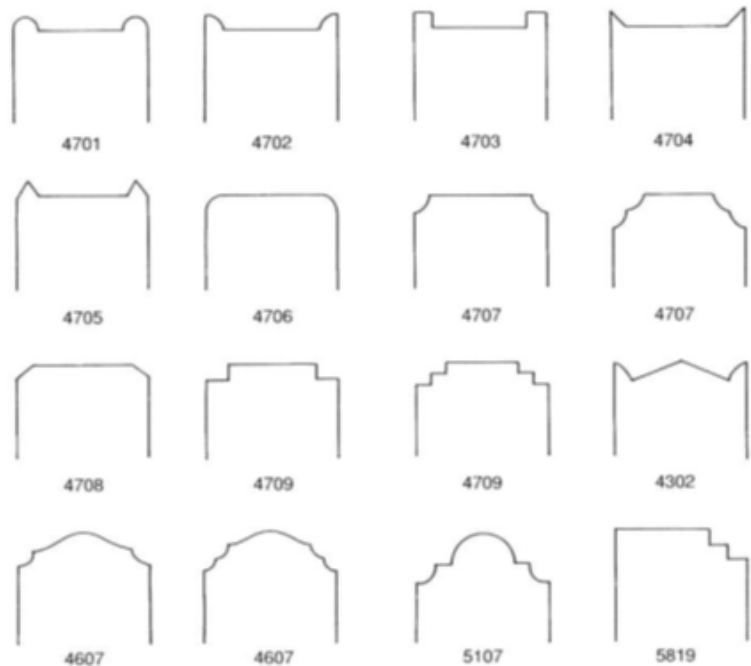

Other features of the headstone

- **10 Indented sides
- **20 Shape of top repeated twice
- **30 Shape of top repeated three times
- **40 Incorporating a scroll
- **50 Small cross on top
- **60 Small ringed cross on top
- **70 Cusped top centre to headstone
- **80 Cut away either side of centre

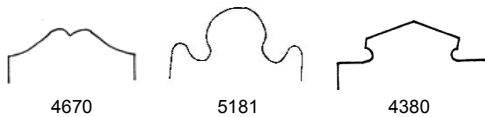

Wall monuments

- 7000 Wall monument
- 7010 Wall monument on church exterior
- 7020 Wall monument on boundary wall
- 7030 Wall monument on freestanding section of wall
- 7050 Panel covering locus for interment in upstanding communal block
- 7060 Panel covering wall niche for cremation

Other monument shapes

7100 Flower holder in place of a stone and no other form of memorial

7300 Thick, low memorial at head of grave – often originally part of a plot with additional kerbs

8100 Desk

8120 Desk with open book

8150 Desk with scroll

8200 Wedge shaped slab

8220 Wedge with open book

8250 Wedge with scroll

8350 Low stone, top shaped like a scroll, but not at the bottom

8400 Rock, rough

8450 Rock, rough, with scroll

8480 Rock, smooth

8500 Log pediment

8600 Heart

8700 Circular disc

8900 Bench as memorial

8960 Plaque on railings/tree

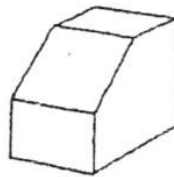

8100

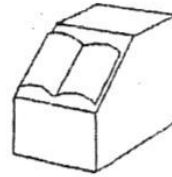

8120

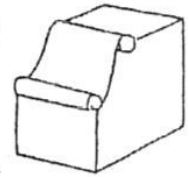

8150

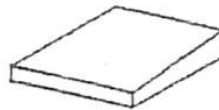

8200



8220



8250



8400



8450



8480



8500



8600



8900

Sculpture

3000 Sculpture

3100 Angel

3110 Angel standing, pointing upwards

3140 Angel seated, mourning

3160 Angel kneeling, praying

3200 Cherub

3400 Virgin Mary

3500 Calvary

3600 Male figure

3650 Male bust

3700 Female figure

3750 Female bust

3800 Other design (e.g. car)

***3 on stepped base

***5 on rocky base

***7 on cubed base

Pedestal tombs

- 9000 Pedestal tomb
- 9100 Columnar pedestal
- 9200 Polygonal pedestal
- 9300 Cube pedestal
- 9400 Cuboid pedestal
- **10 2nd stage cube/cuboid
- **20 2nd stage gable
- **30 2nd stage Gothic structure
- **40 2nd stage obelisk
- **50 2nd stage pyramid
- **60 2nd stage dome
- **70 2nd stage column
- **80 2nd stage broken column
- **90 2nd stage sarcophagus
- ***1 Topped with urn
- ***2 Topped with draped urn
- ***3 Topped with finial
- ***4 Topped with a sphere
- ***5 Topped with a neo-classical sarcophagus
- ***6 Topped with a gothic cross
- ***7 Topped with a cross
- ***8 Topped with a ringed cross

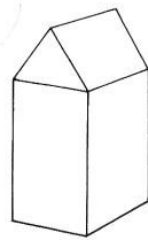

9420

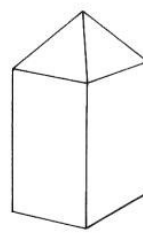

9450

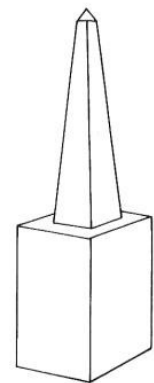

9440

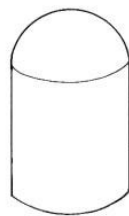

9160

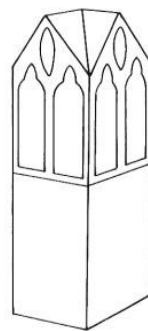

9430

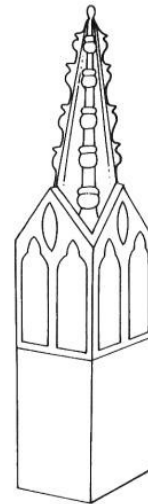

9433

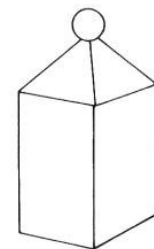

9454

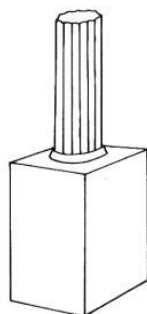

9470

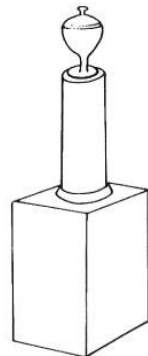

9471

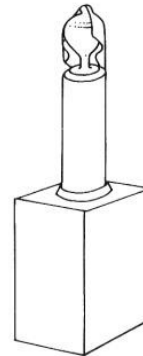

9472

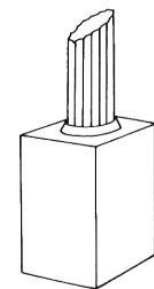

9480

Mausolea, partially subterranean vaults and other upstanding structures

- | | |
|--|---|
| <ul style="list-style-type: none"> 9500 Major upstanding structure 9550 Columbarium for cremations 9600 Large box shape tomb
with the main additional visual feature: <ul style="list-style-type: none"> 9620 flat slab 9622 scroll 9625 open book 9630 vertical headstone 9640 cross (horizontal) 9650 cross (vertical) 9660 sculpture | <ul style="list-style-type: none"> 9800 Mausoleum 9840 Classical revival mausoleum 9850 Egyptian revival mausoleum 9860 Gothic revival mausoleum 9900 Partially subterranean vault 9910 with barrel vault just visible 9920 with barrel vault roof and vertical sides 9930 with gabled roof and vertical sides 99*5 with ends that extend higher than the main tomb roof |
|--|---|

Additional elements

Additional elements refer to features associated with a memorial, usually a headstone.

The first digit refers to the presence or absence of footstones. Footstones may be blank or they may have dates and initials inscribed on them that link them to the people commemorated on the headstone. They will not have a full inscription.

The second digit refers to the presence or absence of body stones or whatever covers the grave in front of the monument. The third digit refers to the presence or absence of kerbs and their design.

The fourth digit refers to the presence or absence of any sort of filling within the kerbs, for example chippings.

For example, 0024 means that a monument has:

0*** no footstone; *0** no body stone; **2* plain kerbs; ***4 pink chipping infill

Box 1

- 0 No foot stone
- 1 Foot stone

Box 2

- 0 No body stone
- 1 Body stone, parallel sided, flat
- 2 Body stone, parallel sided, raised
- 3 Body stone raised more like a tomb
- 4 Body stone, coffin shaped, flat
- 5 Body stone, coffin shaped, raised
- 6 Wrapped body shape
- 8 Flower holder built in at the base

Box 3

- 0 No kerb
- 1 Kerbs
- 2 Plain kerbs
- 3 Kerbs with posts at feet
- 4 Kerbs with posts at head and foot
- 5 Kerbs with two pairs of posts,
neither at the head
- 6 Kerbs with three posts on each side
- 7 Kerbs with railings
- 8 Kerbs with chains or other fittings
- 9 Kerbs ornately carved and shaped

Box 4

- 0 No chippings
- 1 Green chippings infill
- 2 White chippings infill
- 3 Grey chippings infill
- 4 Pink chippings infill
- 5 Peat or soil infill
- 6 Gravel/Pebbles
- 7 Shale Fragments
- 9 Other

Text Panels

Many monuments have text set in a panel. This may mirror the shape of the stone, but often it is of a different shape. If there are two panels on a headstone the panel at the top of the headstone would be entered first. The codes for the text panel shapes are made up of 4 parts. For example, 8270 represents: 8*** is a vertical rectangle; *2** is a semicircular central feature; **70 has concave shoulders or corners.

Shape of text panels

- 1000 Square
- 2000 Circle
- 2300 Oval, vertical
- 2500 Oval, horizontal
- 2800 Octagon
- 2900 Lozenge
- 3000 Sarcophagus
- 4000 Shield
- 5000 Cartouche
- 6000 Open Book
- 7000 Rectangle, horizontal
- 8000 Rectangle vertical
- 9000 Scroll
- Text panel with:
- *100 Rounded top
- *200 Semicircular central feature
- *300 Pointed top
- *400 Triangular top
- *500 Triangular central feature
- *600 Slightly curved top
- *700 Slightly curved central feature
- *800 Sinuous top
- **60 Convex shoulders/corners
- **70 Concave shoulders/corners
- **80 Angled shoulders/corners
- **90 Stepped shoulders/corners
- ***2 Shape repeated twice
- ***3 Shape repeated three times

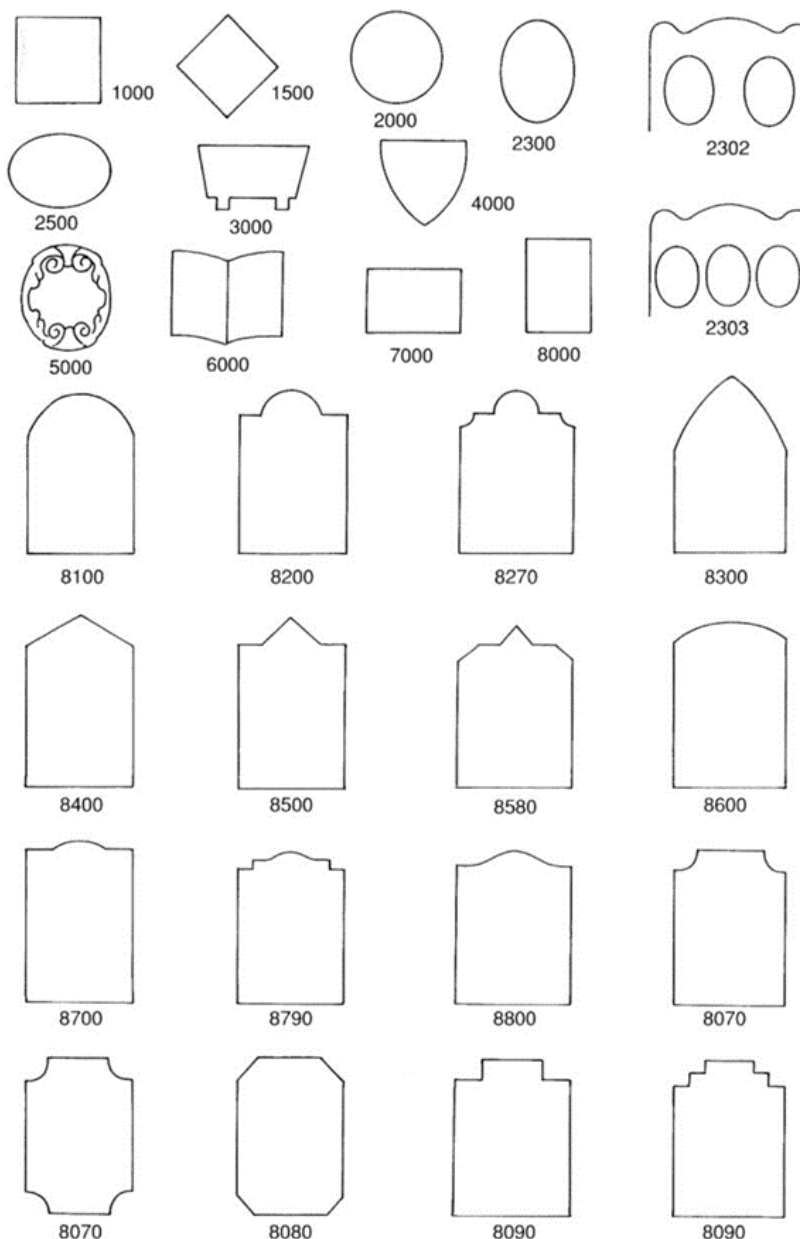

Definition of text panel

- 1 Incised design
- 2 Moulded design
- 3 Relief decoration (e.g. a wreath)
- 4 Inset panel, flat surface
- 5 Inset panel, convex surface
- 6 Raised flat panel
- 7 Raised convex panel

Technique of inscription

There tends to be a fairly restricted number to techniques used in inscriptions, though on the same monument there may be several treatments.

Where a letter is inlaid, this does not also count as incised, even though there has to be incision or cutting to prepare for the inlay. Where the inlay has fallen out, as is quite common with the normal soft black lead lettering, the small drill peg holes, which should still be visible, indicate that this was not incised lettering and so should be coded as inlaid.

Raised inlaid lettering is not where lead lettering is gradually coming out (or the marble has eroded back) but is deliberately created to stand above the surface; it is often chunky lettering in black.

1 Incised	3 Relief	5 Incised painted	7 Raised inlaid
2 Inlaid	4 Painted	6 Relief painted	8 Applied

Letter styles

A basic set of different generic styles is offered here. Often more than one letter style will be used on a monument.

010 Cyrillic lettering

020 Chinese lettering

030 Arabic lettering

040 Hebrew lettering

050 Korean lettering

060 Greek lettering

100 Roman

150 Roman Italic

200 San Serif

250 San Serif Italic

300 Clarendon

400 Egyptian

450 Egyptian Italic

500 Copper Plate

600 Gothic

800 Bold with serifs

900 Thin

950 Other

960 Flared

Roman

A B C D E F G H I J K L M N O P Q R S T U V W X Y Z
a b c d e f g h i j k l m n o p q r s t u v w x y z

Roman italic

A B C D E F G H I J K L M N O P Q R S T U V W X Y Z
a b c d e f g h i j k l m n o p q r s t u v w x y z

Sans serif

A B C D E F G H I J K L M N O P Q R S T U V W X Y Z
a b c d e f g h i j k l m n o p q r s t u v w x y z

Clarendon

A B C D E F G H I J K L M N O P Q R S T U V W X Y Z
a b c d e f g h i j k l m n o p q r s t u v w x y z

Egyptian

A B C D E F G H I J K L M N O P Q R S T U V W X Y Z
a b c d e f g h i j k l m n o p q r s t u v w x y z

Copper plate

A B C D E F G H I J K L M N O P Q R S T U V W X Y Z
a b c d e f g h i j k l m n o p q r s t u v w x y z

Gothic

A B C D E F G H I J K L M N O P Q R S T U V W X Y Z
a b c d e f g h i j k l m n o p q r s t u v w x y z

Decorative motifs

For a headstone the 'central' motifs are those found in the centre and across the top of the stone. The motif to be recorded first should be the most visible. The 'marginal' motifs on a headstone will be found down the edges and they often include architectural designs such as columns, rope work and foliage.

Central decorative motifs

Mortality:

- 110 Separate bones
- 111 Crossbones
- 112 Skull and bones
- 121 Skull facing forward
- 122 Skull facing sideways
- 125 Winged skull
- 130 Skeleton
- 135 Bell
- 140 Hour glass
- 145 Winged hour glass
- 147 Sundial
- 148 Candles
- 150 Coffin
- 152 Spade
- 154 Pick
- 160 Scythe
- 162 Father Time
- 170 Torches pointing down
- 171 Torches pointing up
- 172 Time's dart
- 173 Death (figure)
- 174 Memento Mori text
e.g. Tempus Fugit
Be ye ready
- 176 Serpent
- 177 Serpent eating its tail
- 180 Scale
- 187 Broken column
- 191 Star
- 192 Moon
- 193 Sun
- 194 Sun rising/setting

Cherubs and Angels:

- 210 Cherub head and wings only
- 212 Two cherubs
- 213 Three cherubs
- 220 Cherub with body
- 230 Cherub with trumpet
- 250 Angel
- 260 Angel kneeling
- 270 Angel flying

Vegetation:

- 300 Flower
- 310 Rosette/marigold
- 311 Rose
- 312 Tulip
- 313 Lily
- 315 Yorkshire rose
- 316 Thistle
- 317 Daffodil
- 320 Flower with broken stem
- 325 Flower with sickle
- 330 Leaves
- 332 Stylised leaves
- 333 Shamrocks
- 335 Vine
- 337 Ivy
- 340 Fruit
- 345 Grapes
- 350 Tree
- 355 Willow
- 357 Palm
- 360 Sheaf of wheat
- 370 Wreath

Crosses:

- 400 Cross
- 405 Cross with expanded terminals
- 410 Celtic/Ring-headed cross
- 420 Maltese cross
- 430 Gothic cross
- 440 Two-barred cross
- 450 Chi Rho

Figures:

- 500 Figure
- 505 Jesus
- 506 Madonna
- 507 Virgin Mary full figure
- 508 Justice with scales
- 509 Head of Jesus
- 510 Portrait of deceased
- 511 Head of Mary
- 515 Saint
- 520 Full figure of deceased alive
- 530 Full figure of deceased dead
- 540 Classical figure, unknown
- 543 Classical figure, Hope with anchor
- 545 Classical figure, mourning
- 547 Classical figure, mourning, with altar/urn
- 550 Anchor
- 580 Other mourning

Christian:

610 Book (uncertain) closed
 611 Trinity
 612 'Gloria in excelsis deo' text
 613 Line of Bosses
 615 Book open
 620 Bible closed
 625 Bible open
 626 Scroll (not pattern or text panel)
 627 Banner
 630 Crown
 631 Crown with radiance
 633 Triangle with radiance
 635 Eye with radiance
 637 Cross with radiance
 640 Crucifixion
 641 Crucifixion – complete scene
 642 Crucifixion – church interior
 645 Symbols of the Passion (see advice documentation)
 650 Crown of thorns
 655 Lamb
 656 Lamb of God with cross, banner
 657 Lamb of God – no banner
 660 Heart
 661 Heart pierced by Time's dart
 662 Sacred Heart
 663 Sacred heart with radiance
 664 'Squirting' heart
 670 IHS
 672 IHS interwoven
 673 IHS with cross on bar of H
 674 as 673 in radiate circle (often dog tooth pattern)
 680 Adam and Eve
 685 Day of Judgement/Resurrection
 686 Day of Judgement/Resurrection with radiance
 688 Alpha and/or Omega

690 Other Biblical
 695 Chalice
 710 Altar
 713 Altar, Christian
 715 Altar, Classical
 720 Tomb
 730 Urn
 735 Draped urn
 740 Romanesque tracery
 750 Gothic tracery in relief
 755 Gothic window
 760 Ecclesiastical building
 761 Gate of St. Peters
 770 Interlace (Celtic)
 780 Vine scrolls with animals, birds

Other:

800 Hand
 810 Hand pointing up
 812 Hand pointing down
 820 Hands clasped/shaking
 825 Hand in prayer
 833 Trefoil
 834 Quatrefoil
 850 Birds
 851 Bird and bush/flower
 852 Feathers
 855 Dove
 860 Animals
 861 Dog
 870 Scrollwork (pattern)
 880 Shell
 883 Palmette
 885 Cornucopia
 890 Fan
 895 Swags of cloth – central
 896 Canopy
 897 Curtains
 900 Masonic symbols
 901 Square and compass
 902 Compass
 903 Square

Other:

909 Horse
 910 Fleur-de-lys
 920 Shield
 921 Diamond
 922 Circle
 924 Full formal Heraldic Arms
 925 Shield with design on it
 926 Lion
 927 Crossed swords
 928 Helmet
 929 Military Regimental insignia
 930 Transport scene
 931 Horseback/cart
 932 Ship
 933 Train
 934 Bicycle
 935 Car
 936 Motor cycle
 937 Lorry/Bus
 938 Aeroplane
 939 Gun/Cannon
 940 Occupation (other)
 941 Ploughing
 945 Blacksmiths tools
 946 Horseshoe
 947 Weaver's tools
 948 Carpenter's tools
 950 Hobby
 955 Toys
 956 Cartoon character
 960 Rural scene
 961 Hunting
 970 Urban scene
 980 Pews
 990 Portrait photograph
 991 Portrait etched

Marginal decorative motifs

200 Columns	450 Fruit	700 Egg and dart
210 Baluster columns	470 Foliage scrolls	710 Triangles
220 Fluted columns	500 Scrolls	720 Gothic arcading
230 Barley sugar spiral columns	550 Circles	730 Ribbons
300 Swags of cloth	600 Rope	800 Border (outline)
400 Leaves	610 Dog tooth	801 Border (decorative)
410 Flowers	620 Gothic crockets	802 Cross
420 Bird with flower		

Tooling back

- 0 Smooth
- 1 Masons Signature
- 2 Rough
- 3 Deep Hand Tooling
- 4 Fine Hand Tooling
- 5 Decorative Tooling
- 6 Machine Cut Tooling
- 9 Other

Tooling sides

- 0 Smooth
- 1 Masons Signature
- 2 Rough
- 3 Deep Hand Tooling
- 4 Fine Hand Tooling
- 5 Decorative Tooling
- 6 Machine Cut Tooling
- 9 Other

Repairs

These can be repairs either to the main monument or the additional features such as kerbs.

- 0 No repairs
- 1 Repairs
- 2 Iron clamps
- 3 Copper alloy clamps
- 4 Lead clamps
- 5 Mortar/concrete/adhesive

Date of monument

One of the most important features to establish about the monument is its date. Occasionally, the date of erection is explicitly stated, but in the vast majority of cases an inference has to be made. Some memorials can be erected before anyone later commemorated on it has died. In other cases, the monument is only put up decades after the last person mentioned, such as with some war memorials. It is normal, however, for the stone to be erected within 2 or 3 years of either the first person mentioned, or the latest in a group all inscribed at the same time when the stone was first used. The date for the monument is therefore inferred from the inscription.

Reason

There are various ways of dating the monument from its inscription and these are coded to make the recorders thought processes clear.

- 1 Stated date of erection
- 2 Inferred date from first mentioned individual
- 3 Inferred date from latest of a group first inscribed together
- 4 Inferred date of footstone from associated monument
- 5 Inferred date from associated headstone
- 9 Dates of those commemorated not relevant to monument date